

39" HD LED TV

User Manual



* Product picture is for reference only.

Model: FDHS39Y1A

Welcome

Thank you for purchasing this Furrion HD LED TV. Before operating your new product, please read these instructions carefully. This user manual contains information for safe use, installation and maintenance of the product.

The manufacturer does not accept responsibility for any damages due to not observing these instructions.

If you have any further questions regarding our products, please contact us at **support@furrion.com**

Supplier's Declaration of Conformity

47 CFR § 2.1077 Compliance Information

Unique Identifier

Trade Name: Furrion

Model No.: FDHS39Y1A

Responsible Party – U.S. Contact Information

Furrion Innovation Center & Institute of Technology

52567 Independence Ct., Elkhart, IN 46514, USA

Toll free: 1-800-789-3341; Email: support@furrion.com

FCC Compliance Statement

This device complies with Part 15 of the FCC Rules. Operation is subject to the following two conditions: (1) This device may not cause harmful interference, and (2) this device must accept any interference received, including interference that may cause undesired operation.

Contents

Welcome	2
Contents	3
Safety Warnings	4
Important Safety Instructions.....	4
Safety Precautions.....	7
Function Overview	9
Control Panel	9
Rear Panel	10
Unimote.....	11
About Your HD LED TV	13
Features	13
Power Source	13
Before Operation	14
What's in the Box.....	14
Prepare your Remote Control	14
Getting Started	15
TV Settings	16
Setup Setting	16
Picture Setting.....	19
Audio Setting.....	20
Time Setting	21
Lock Setting	22
Channel Setting	24
Change Settings	25
USB Mode	25
Troubleshooting	26
Specifications	27

Safety Warnings



CAUTION
RISK OF ELECTRIC SHOCK
DO NOT OPEN



CAUTION: TO REDUCE THE RISK OF ELECTRIC SHOCK, DO NOT REMOVE COVER (OR BACK). NO USER-SERVICEABLE PARTS INSIDE. REFER SERVICING TO QUALIFIED SERVICE PERSONNEL.



This 'bolt of lightning' indicates uninsulated material within your unit which may cause an electric shock. For the safety of everyone in your household, please do not remove product covering.



The 'exclamation mark' calls attention to features within the enclosed literature to prevent operating and maintenance problems.



This equipment is a Class II or double insulated electrical appliance. It has been designed in such a way that it does not require a safety connection to electrical earth.

WARNING: To reduce the risk of fire or electric shock, this apparatus should not be exposed to rain, moisture placed in the vicinity or objects filled with liquids (such as vases).

CAUTION: To prevent electric shock, fully insert the plug. For regions with polarized plugs: Please match wide blade to wide slot.

Important Safety Instructions

1. Read these instructions.
2. Keep these instructions.
3. Heed all warnings.
4. Follow all instructions.
5. Do not use this apparatus near water.
6. Clean only with a dry cloth.
7. Do not block any of the ventilation openings. Install in accordance with the manufacturers instructions.
8. Do not install near any heat sources such as radiators, heat registers, stoves or other apparatus (including amplifiers) that produce heat.
9. Do not defeat the safety purpose of the polarized or grounding-type plug. A polarized plug has two blades with one wider than the other. A grounding type plug has two blades and a third grounding prong. The wide blade or the third prong are provided for your safety. When the provided plug does not fit into your outlet, consult an electrician for replacement of the obsolete outlet.
10. Protect the power cord from being walked on or pinched, particularly at plugs, convenience receptacles and the point where they exit from the apparatus.
11. Only use attachments/accessories specified by the manufacturer.
12. Use only with a cart, stand, tripod, bracket or table specified by the manufacturer or sold with the apparatus. When a cart is used, use caution when moving the cart/apparatus to avoid injury from tip-over.
13. Unplug this apparatus during lightning storms or when unused for long periods of time.
14. Refer all servicing to qualified service personnel. Servicing is required when the apparatus has been damaged in any way, such as if the power-supply cord or plug is damaged, liquid has been spilled or objects have fallen into the apparatus, or when the apparatus has been exposed to rain or moisture, does not operate normally, or has been dropped.
15. Apparatus should not be exposed to dripping or splashing, and objects filled with liquids, such as vases, should not be placed on the apparatus.



Safety Warnings

- An outside antenna system should not be located in the vicinity of overhead power lines or other electric light or power circuits, or where it can fall into such power lines or circuits. When installing an outside antenna system, extreme care should be taken to eliminate touching power lines or circuits as contact might be fatal.
- Do not overload wall outlets, extension cords, or integral convenience receptacles as this can result in a risk of fire or electric shock.
- Never push objects of any kind into this product through openings as they may touch short-out parts or dangerous voltage points that could result in a fire or electric shock. Never spill liquid of any kind on the product.
- If an outside antenna is connected to the television equipment, be sure the antenna system is grounded so as to provide some protection against voltage surges and built up static charges. Section 810 of the National Electrical Code provides information with respect to proper grounding of the mast and supporting structure, grounding of the lead-in wire to an antenna discharge unit, size of grounding conductors, location of antenna discharge unit, connection to grounding electrodes, and requirements for the grounding electrodes.

- NOTE TO CABLE/TV INSTALLER: This reminder is provided to call the CATV system installer's attention to Article 820-40 of the National Electric Code (U.S.A.). The code provides guidelines for proper grounding and, in particular, specifies that the cable ground shall be connected to the grounding system of the building, as close to the point of the cable entry as practical.
- When replacement parts are required, be sure the service technician uses replacement parts specified by the manufacturer or those that have the same characteristics as the original part. Unauthorized substitutions may result in fire, electric shock or other hazards.
- Upon completion of any service or repairs to this unit, ask the service technician to perform safety checks to determine that the unit is in proper operating condition.
- When you connect the product to other equipment, turn off the power and unplug from the wall outlet. Failure to do so may cause an electric shock and serious personal injury. Read the owner's manual of the other equipment carefully and follow the instructions when making any connections.
- Sudden high volume may cause hearing or speaker damage. When you use headphones (if the unit is equipped with a headphone jack), keep the volume at a moderate level. If you use headphones continuously with high volume, you may suffer hearing damage.
- Do not allow the product to output distorted sound for extended periods of time. This may cause speaker overheating and fire.
- The socket-outlet must be installed near the unit and easily accessible.
- The mains plug is used as the disconnect and shall remain readily operable.

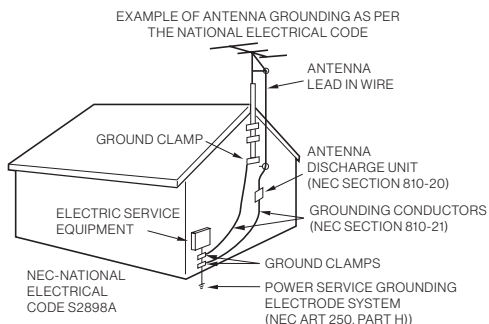

Safety Warnings

28. Batteries (battery pack or batteries installed) shall not be exposed to excessive heat such as sunshine, fire or the like.

CONDENSATION

Moisture will form in the operating section of the unit if the unit is brought from cool surroundings into a warm room or if the temperature of the room rises suddenly. When this happens the unit's performance will be impaired. To prevent this, let the unit stand in its new surroundings for about an hour before switching on, or make sure the room temperature rises gradually.

Condensation may also form during the summer if the unit is exposed to the breeze from an air conditioner. In such cases, change the location of the unit.

HOW TO HANDLE THE LED PANEL

- Do not press hard or jolt the LED panel. It may cause the LED panel glass to break and injury may occur.
- If the LED panel is broken, make absolutely sure you do not touch the liquid in the panel. This may cause skin inflammation.
- If the liquid gets in your mouth, immediately gargle and consult with your doctor. Also, if the liquid gets in your eyes or touches your skin, consult your doctor after rinsing for at least 15 minutes in clean water.

Possible Adverse Effects on LED Panel: If a fixed (non-moving) pattern remains on the LED panel for long periods of time, the image can become permanently engrained and cause subtle but permanent ghost images. This type of damage is NOT COVERED BY YOUR WARRANTY. Never leave your LED panel on for long periods of time while it is displaying the following formats or images:

- Fixed images, such as stock tickers, video game patterns, TV station logos and websites.
- Special formats that do not use the entire screen. For example, viewing letterbox style (16:9) media on a normal (4:3) display (black bars at top and bottom of screen); or viewing normal style (4:3) media on a wide screen (16:9) display (black bars on left and right sides of screen).

The following symptoms are not signs of malfunction but technical limitation. Therefore we disclaim any responsibility for these symptoms.

- LED panels are manufactured using an extremely high level of precision technology, however sometimes parts of the screen may be missing picture elements or have luminous spots. This is not a sign of a malfunction.
- Do not install the LED panel near electronic equipment that produces electromagnetic waves. Some equipment placed too near this unit may cause interference.
- Effect on infrared devices – there may be interference while using infrared devices such as infrared cordless headphones.

Power source: This LED TV is designed to operate on 100~240 volt 50/60 Hz, AC current. Insert the power cord into a 100~240 volt 50/60 Hz outlet.

To prevent electric shock, do not use the LED TV's (polarized) plug with an extension cord, receptacle, or other outlet unless the blades and ground terminal can be fully inserted to prevent blade exposure.

Warning: To reduce the risk of fire or electric shock, do not expose this apparatus to rain or moisture.

Safety Warnings

Caution: Never remove the back cover of the LED TV as this can expose you to very high voltages and other hazards. If the TV does not operate properly, unplug the LED TV and call your authorized dealer or service center.

Adjust only those controls that are covered in the instructions, as improper changes or modifications not expressly approved by Furrion could void the user's warranty.

COMPLIANCE

FCC Statement

Note: This equipment has been tested and found to comply with the limits for a Class B digital device, pursuant to Part 15 of the FCC Rules. These limits are designed to provide reasonable protection against harmful interference in a residential installation. This equipment generates, uses and can radiate radio frequency energy and, if not installed and used in accordance with the instructions, may cause harmful interference to radio communications.

However, there is no guarantee that interference will not occur in a particular installation. If this equipment does cause harmful interference to radio or television reception, which can be determined by turning the equipment off and on, the user is encouraged to try to correct the interference by one or more of the following measures:

- Reorient or relocate the receiving antenna.
- Increase the separation between the equipment and receiver.
- Connect the equipment into an outlet on a circuit different from that to which the receiver is connected.
- Consult the dealer or an experienced radio/TV technician for help.

WARNING: Changes or modifications to this unit not expressly approved by the party responsible for compliance could void the user's authority to operate this equipment under FCC Rules.

This device complies with part 15 of the FCC Rules. Operation is subject to the following two conditions:

1. This device may not cause harmful interference.
2. This device must accept any interference received, including interference that may cause undesired operation.

Safety Precautions

WARNING: Never place a television set in an unstable location. A television set may fall, causing serious personal injury or death. Many injuries, particularly to children, can be avoided by taking simple precautions such as:

- Using cabinets or stands recommended by the manufacturer of the television set.
- Only using furniture that can safely support the television set.
- Ensuring the television set is not overhanging the edge of the supporting furniture.
- Not placing the television set on tall furniture (for example, cupboards or bookcases) without anchoring both the furniture and the television set to a suitable support.
- Not placing the television set on cloth or other materials that may be located between the television set and supporting furniture.
- Educating children about the dangers of climbing on furniture to reach the television set or its controls.

Safety Warnings

If your existing television set is being retained and relocated, the same considerations as above should be applied.

The unit emits heat when in operation. Do not place any covers or blankets on the unit, this may cause overheating. Do not block ventilation holes, or set up near radiators. Do not place in direct sunlight. When placing on a shelf, leave 4 inches (10 cm) free space around the entire unit.

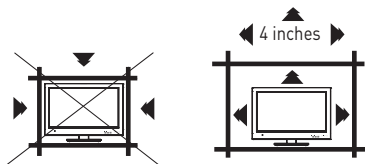

Notes when mounting the LED TV on the wall

If the unit is to be mounted on the wall, contact the retailer where you purchased the LED TV for advice, and have the equipment professionally installed. Incomplete or improper installation may cause injury to you and/or damage to the LED TV.

WARNING:

- Do not use this TV with wall mounts that allow the TV to tilt vertically. Vertical tilting wall mounts may cause structural damage to the TV.
- Use **ONLY** fixed or horizontal swiveling wall mounts with this TV.

Notice for TV Cabinet

If the unit is to be mounted on a cabinet smaller than the length of the unit, it could result in an unstable location. The unit may tumble over, making a risk of personal, possibly fatal injury. This would also damage the product seriously. Accordingly, Furrion accepts no responsibility or liability for any injuries or property damage resulting from the improper installation.

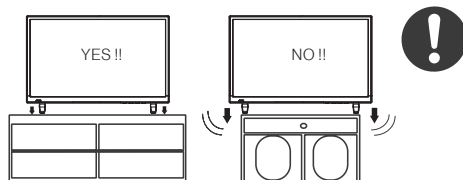

Function Overview

Control Panel

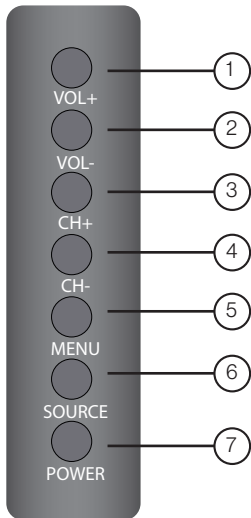

Item	Button	Function
①	VOL+	Press to increase volume
②	VOL-	Press to decrease volume
③	CH+	Press to skip to the next channel
④	CH-	Press to skip to the previous channel
⑤	MENU	Press to enter the main menu
⑥	SOURCE	Press to select the input source
⑦	POWER	Press to switch the TV on/off

* Please note that the button layout of the controls may vary from model to model.

Function Overview

Rear Panel

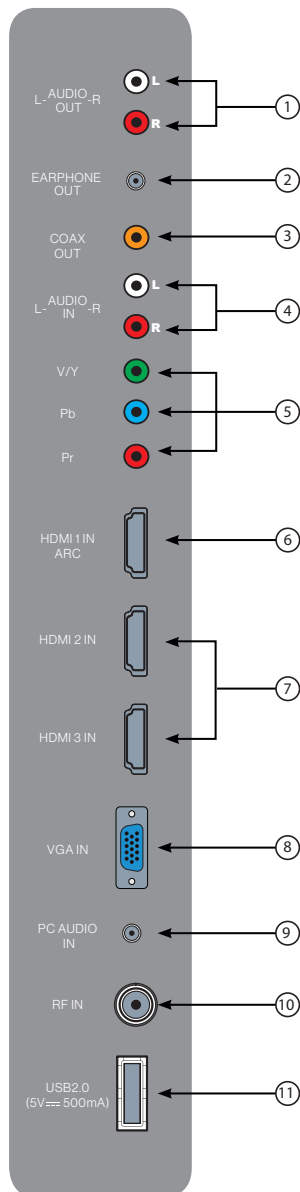

Item	Port	Function
①	L-AUDIO OUT-R	Connect to the AUDIO IN ports of an audio device.
②	EARRPHONE OUT	Connect to the 3-conductor (TRS) phone connector of an earphone. Compatibility with earphones with 4-conductor (TRRS) phone connectors is not guaranteed.
③	COAX OUT	Connect to the COAX IN port of an audio device.
④	L-AUDIO IN-R	Connect to the AUDIO OUT ports of an audio device.
⑤	V/Y P _b P _r	Connect to the COMPONENT VIDEO OUT ports of a DVD Player, Cable Box or other compatible device.
⑥	HDMI 1 IN ARC	Connect to the HDMI OUT port of a DVD Player, Games Console, Cable Box or other HDMI device. • ARC (Audio Return Channel) When connected with a HDMI 1.4 cable to an ARC compatible audio system, the TV links with the device to give extra audio functionality.
⑦	HDMI 2 IN HDMI 3 IN	Connect to the HDMI OUT port of a DVD Player, Games Console, Cable, Box or other HDMI device. • CEC (Consumer Electronics Control) When connected to the CEC compatible Furrion Entertainment Systems or other CEC compatible devices, the TV links with the system to give extra functionality.
⑧	VGA IN	Connect to the VGA OUT port of a PC to use the TV as a monitor.
⑨	PC AUDIO IN	Connect to the AUDIO OUT port of a PC.
⑩	RF IN	Connect to the ANTENNA, CABLE, or CABLE BOX.
⑪	USB	Connect to portable USB device to view pictures and listen to MP3.

* The configuration of the connection ports may vary from model to model.

Function Overview



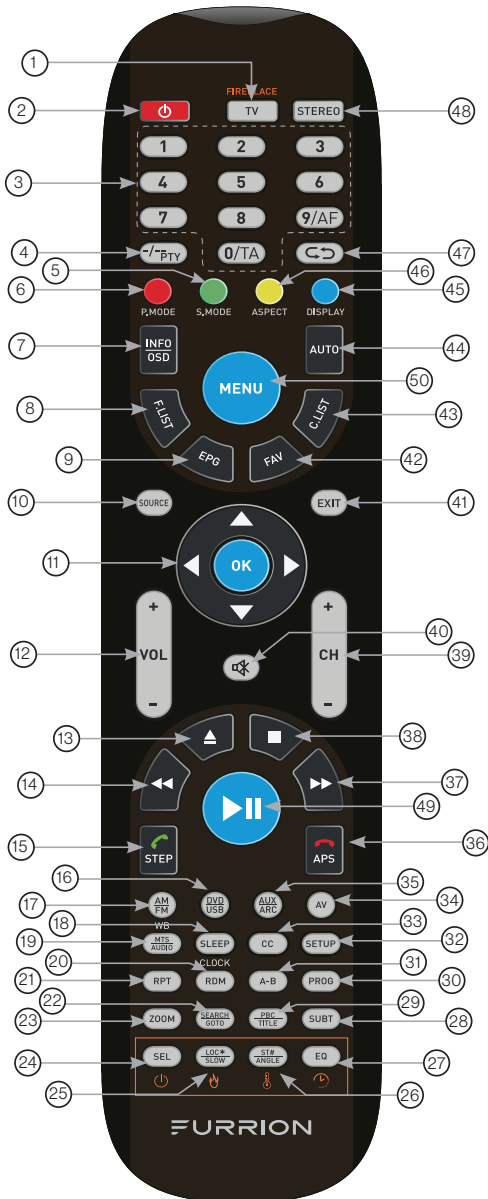



Unimote



Item	Button	Function
①	TV	Switches to TV mode.
	FIREPLACE	Selects Furrion Fireplace remote control functions. * Please refer to your Furrion Fireplace manual for more information.
②		Turn on/off the TV/ Entertainment System.
③	NUMBER BUTTONS	Enters numbers or select channels.
④		Toggles between single & double digit input.
⑤	S.MODE	Cycles through sound modes.
⑥	P.MODE	Cycles through picture modes.
⑦	INFO/OSD	In TV mode, press to display information on the selected TV channel; In Stereo mode, press to display DVD playback status.
⑧	F.LIST	Displays the favorites list.
⑨	EPG	Displays the program guide.
⑩	SOURCE	Cycles through input sources.
⑪	NAVIGATION & OK BUTTONS	Navigates within a menu and press OK to confirm your selection.
⑫	VOL +/-	Increases/decreases volume.
⑬		Ejects DVD/ CD.
⑭		During playback, press to select the previous track/ chapter. Press and hold to rewind. Automatic or Manual tuning in radio mode.
⑮	STEP	Press to forward frame by frame during DVD/ VCD playback. Dial or accept a call (when the system is connected to a cell phone).

Function Overview

Item	Button	Function
16	DVD/USB	Selects DVD/USB.
17	AM/FM	Selects AM/FM/WB Radio.
18	SLEEP/CLOCK	Sets the sleep timer.
19	MTS/AUDIO	Cycles through MTS sound modes.
20	RDM	Toggles random playback mode on & off.
21	RPT	Press to select repeat playback modes.
22	SEARCH/GOTO	Jumps to a specific time on a DVD/VCD/MP3/WMA or CD.
23	ZOOM	Press to enlarge screen images.
24	SEL	Toggles between Volume, Bass, Treble & Balance; Adjusts hours & minutes.
25	LOC*/SLOW	Toggles radio reception strength; Press to start slow motion playback.
26	ST#/ANGLE	Toggles Stereo & Mono sound/ switches viewing angles on compatible media.
27	EQ	Toggles the sound mode Cinema, Rock, Classic & Flat.
28	SUBT	Press to display subtitles on compatible media; Repeatedly press to cycle through subtitle options.
29	PBC/TITLE	Displays DVD/VCD Title lists; Toggles PBC (Play Back Control) on & off.
30	PROG	Press to start the programmed playback function.
31	A-B	Press to start the A-B repeat function (playback loop of a segment of track).
32	SETUP	Enters the Setup menu for the entertainment system.

Item	Button	Function
33	CC	Closed Captions On & Off.
34	AV	Selects AV Mode.
35	AUX/ARC	Selects AUX/ ARC Mode.
36	 APS	Press to scan radio stations: A brief press searches through each stored station. Press & hold to scan and store the 6 strongest stations. End or reject a call (when the system is connected to a cell phone).
37		During playback, press to select the next track/ chapter. Press and hold to fast forward. Automatic or Manual tuning in radio mode.
38		Stops playback.
39	CH+/-	Channel Up/Down.
40		Toggles audio On or Off.
41	EXIT	Exits the current menu.
42	FAV	Adds or deletes the current channel from the favorites channel list.
43	C.LIST	Displays the channel list.
44	AUTO	Automatically adjusts the picture in PC mode.
45	DISPLAY	Display the information.
46	ASPECT	Cycles through available display aspect ratios.
47		Toggles between the current and previous channel.
48	STEREO	Switches to Stereo mode.
49		Starts, Pauses or restarts playback.
50	MENU	Enters the main menu.

About Your HD LED TV

Features

Closed Caption Decoder With Full Text Mode - Displays text captions or full screen text on the screen for hearing impaired viewers.

Picture Adjustments Using The Remote Control - The On-Screen display allows precise remote control adjustment of BRIGHTNESS, CONTRAST, COLOR, TINT and SHARPNESS.

Programmable TV Sleep Timer - Operable from the remote control, the TV can be programmed for up to 240 minutes to turn off automatically.

On-Screen 3 Language Display - You can select one of 3 languages, English, Spanish or French for on-screen programming.

HDMI/Component Video Jacks - A VCR, DVD player, satellite receiver or other audio/video component can be connected to this unit.

Power Source

NOTE:

- Please make sure to insert the cord securely at both the LED TV and the wall outlet.

WARNING:

- DO NOT CONNECT THIS UNIT TO THE POWER USING ANY DEVICE OTHER THAN THE SUPPLIED AC CORD. THIS COULD CAUSE FIRE, ELECTRICAL SHOCK, OR DAMAGE.
- DO NOT USE WITH A VOLTAGE OTHER THAN THE POWER VOLTAGE SPECIFIED. THIS COULD CAUSE FIRE, ELECTRICAL SHOCK, OR DAMAGE.

CAUTION:

- WHEN THIS UNIT IS NOT USED FOR A LONG TIME (E.G., AWAY ON A TRIP), IN THE INTEREST OF SAFETY, BE SURE TO UNPLUG IT FROM THE AC OUTLET.
- DO NOT PLUG/UNPLUG THE AC CORD WHEN YOUR HANDS ARE WET. THIS MAY CAUSE ELECTRICAL SHOCK.
- IF YOU NEED TO REPLACE THE SUPPLIED AC ADAPTER OR AC CORD, THE SPECIFIED ONE IS RECOMMENDED. CONTACT THE DEALER THAT YOU PURCHASED THE UNIT FROM.

Before Operation

What's in the Box

Thanks for purchasing this Furrion HD LED TV. First, check the contents of your box with the parts checklist below:

- HD LED TV x 1
- AAA battery x 2
- Bottom Mount Stand x 1
- TV Stands Screws x 4
- Wall Mount Screws (M6*10mm) x 4
- Quick Start Guide x 1
- Warning Card x 1
- Warranty Manual x 1

Prepare your Remote Control

BATTERY INSTALLATION

1. Open battery compartment cover.

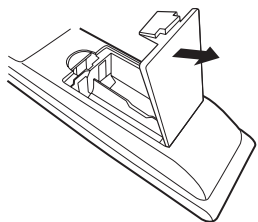

2. Install two AAA batteries.

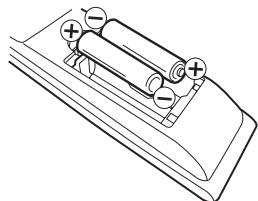

3. Close the cover of the battery compartment.

NOTE: Use two “AAA” size batteries. The batteries may last approximately one year depending on how much the remote control is used. For best performance, it is recommended that batteries should be replaced on a yearly basis, or when the remote operation becomes erratic. Do not mix old and new batteries or different types.

BATTERY PRECAUTIONS

These precautions should be followed when using batteries in this device:

- Use only the size and type of batteries specified.
- Be sure to follow the correct polarity when installing the batteries as indicated in the battery compartment. Reversed batteries may cause damage to the device.
- Do not mix different types of batteries together (e.g. Alkaline and Carbon-zinc) or old batteries with fresh ones.
- If the device is not to be used for a long period of time, remove the batteries to prevent damage or injury from possible battery leakage.
- Do not try to recharge batteries not intended to be recharged; they can overheat and rupture. (Follow battery manufacturer's directions.)
- Please use caution when inserting batteries to avoid battery damage. If the spring terminal in the remote control remains in contact with a side of a damaged battery it can cause a short circuit. Never use damaged batteries as they can become very hot and are dangerous.

Getting Started

The **Setup Wizard** window appears when turning on the TV for the first time and without channel scanning. After connecting your TV antenna or cable wire, turn the television ON. The Setup Wizard will direct you to the TV menu to select antenna options and perform channel Auto Scan. Channels found will be stored into the TV tuner memory.

1. Press **▲ / ▼** buttons to highlight **Menu Language** and then use **◀ / ▶** buttons to select desired language.
2. Press **▲ / ▼** buttons to highlight **Air/Cable** and then use **◀ / ▶** buttons to select **Air** or **Cable** based on your antenna connection.
3. Press **▲ / ▼** buttons to highlight **Auto Scan** and press **OK / ▶** buttons to run auto scanning. It may take several minutes to complete channel **Auto Scan**.

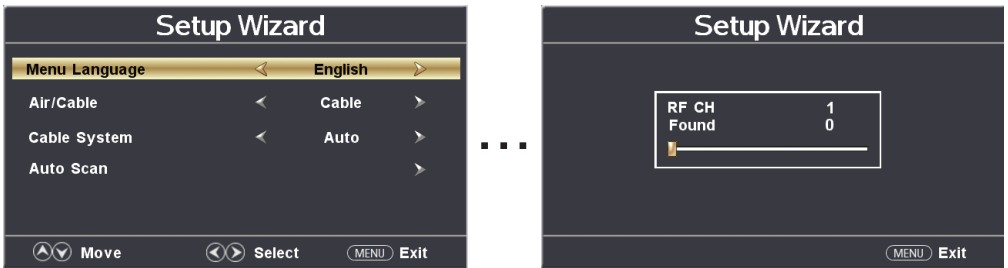

TV Settings

Setup Setting

1. Press **MENU** button to remote control to enter the main menu.
2. Use ◀ or ▶ to highlight **Setup** mode.
3. Use ▲ or ▼ to highlight the item you would like to reset, then press ◀ or ▶ to select the settings.
4. Press **MENU** to return to the previous menu or press **EXIT** at any time to exit the setting.



Setup Menu

Menu Language	Select the menu language.	Press ◀ or ▶ button to select English, Français or Español .
Transparency	Adjust the transparency of the OSD (on screen display) menu.	Press ◀ or ▶ button to select On/Off .
Zoom Mode	Adjust the display width on screen.	Press ◀ or ▶ button to select Wide, Normal, Cinema, Zoom .
Noise Reduction	Adjust the level of noise reduction..	Press ◀ or ▶ button to select Weak, Middle, Strong, Off .
Advanced	This is not user adjustable.	
Source Label	Create labels for the devices connected to your TV.	Press ▶ button to enter the sub-menu. Press ▲ or ▼ buttons to highlight the input source TV//AV/Component/HDMI1/HDMI2/HDMI3/PC/USB to be labeled. Then press ◀ or ▶ buttons to select Custom, Default, Antenna, Cable, Satellite, DTV, DVD, Blu-ray, HD-DVD, XBOX, Wii, PS3, Game, Computer, VCR or DV .

TV Settings

Setup Menu

Closed Caption	Configure Closed Caption functions.	CC Mode	Press ◀ or ▶ button to select Off, On or CC On Mute .	
		Basic Selection	Press ◀ or ▶ button to select CC1, CC2, CC3, CC4, Text 1, Text 2, Text 3 or Text 4 .	
		Advanced	Press ◀ or ▶ button to select Service1, Service 2, Service 3, Service 4, Service 5 or Service 6 .	
		Option * Press ▶ to enter the sub menu to customize text fonts, colors and opacity.	Mode	Press ◀ or ▶ button to select Default or Custom .
			Font Style	Press ◀ or ▶ button to select Default, Font 0, Font 1, Font 2, Font 3, Font 4, Font 5, Font 6 or Font 7 .
			Font Size	Press ◀ or ▶ button to select Default, Normal, Large or Small .
			Font Edge Style	Press ◀ or ▶ button to select Default, None, Raised, Depressed, Uniform, Left Shadow or Right Shadow .
			Font Edge Color	Press ◀ or ▶ button to select Default, Black, White, Red, Green, Blue, Yellow, Magenta or Cyan .
			FG Color	Press ◀ or ▶ button to select Default, White, Red, Green, Blue, Yellow, Magenta or Cyan .
			BG Color	Press ◀ or ▶ button to select Default, Black, Red, Green, Blue, Yellow, Magenta or Cyan .
FG Opacity	Press ◀ or ▶ button to select Default, Solid, Flashing, Translucent or Transparent .			
	BG Opacity	Press ◀ or ▶ button to select Default, Solid, Flashing, Translucent or Transparent .		
DLC	Turn on/off the DLC.	Press ◀ or ▶ button to select On/Off .		
Setup Wizard	Start the Setup Wizard.	Press OK or ▶ button to enter Setup Wizard .		

TV Settings

Setup Menu

HDMI CEC	<p>Press ► to enter sub-menu, then press ◀ or ► to select Off /On for HDMI CEC. When selecting On, the sub-menu in the right column will be available to set up.</p>	HDMI CEC	Press ▲ OR ▼ button to select HDMI CEC , and then press ◀ or ► button to select On/Off .
		Auto Standby	Press ▲ OR ▼ button to select Auto Standby , and then press ◀ or ► button to select On/Off . If you select On , the TV will turn off automatically when there's no signal on TV for several minutes.
		Auto TV On	Press ▲ OR ▼ button to select Auto TV On , and then press ◀ or ► button to select On/Off . If you select On , the TV will turn on automatically when the connected CEC device is turned on.
		HDMI ARC	Press ▲ OR ▼ button to select Auto TV On , and then press ◀ or ► button to select On/Off . If you select On , it enables the ARC function with a connected 5.1 / 7.1 Home Theater System. (Note: Refer to the user manual of your Home Theater System to operate the HDMI ARC feature.)
		Device Control	Press ▲ OR ▼ button to select Device Control , and then press ◀ or ► button to select On/Off . If you select On , it allows a connected CEC device to be controlled by the TV remote.(Note: Refer to the user manual of your connected CEC device for compatibility, instructions, and connections.).
		Device List	Press ► to display a list of HDMI CEC devices currently connected to the TV.
Restore Default	Reset all settings to factory settings.	Press ► button to select No or Yes to reset all to original factory settings.	

TV Settings

Picture Setting

1. Press **MENU** button to remote control to enter the main menu.
2. Use ◀ or ▶ to highlight **Picture** mode.
3. Use ▲ or ▼ to highlight the item you would like to reset, then press ◀ or ▶ to select the settings.
4. Press **MENU** to return to the previous menu or exit the setting.

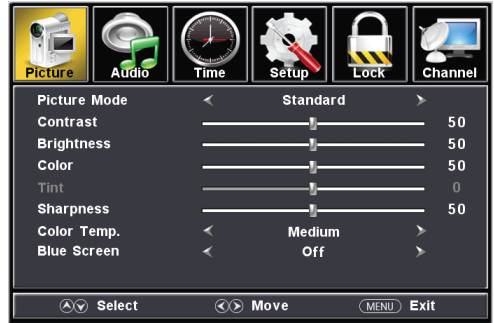

Picture Menu		
Picture Mode	Select the display mode.	Press ◀ or ▶ button to select Energy Saving > User > Standard > Dynamic > Mild .
Contrast	Control the contrast level of the picture.	Press ◀ or ▶ button to increase or decrease contrast intensity.
Brightness	Control the brightness level of the picture.	Press ◀ or ▶ button to increase or decrease the overall brightness.
Color	Control the color level of the picture.	Press ◀ or ▶ button to increase or decrease the color intensity.
Tint	Control picture tint.	Press ◀ or ▶ button to adjust colors toward green or reddish tint.
Sharpness	Control the sharpness of the picture.	Press ◀ or ▶ button to soften or view crisper edges in the picture.
Color Temperature	Select the color mode.	Press ◀ or ▶ button to select Cool, Medium or Warm .

TV Settings

Audio Setting

1. Press **MENU** button to remote control to enter the main menu.
2. Use ◀ or ▶ to highlight **Audio** mode.
3. Use ▲ or ▼ to highlight the item you would like to reset, then press ◀ or ▶ to select the settings.
4. Press **MENU** to return to the previous menu or press **EXIT** at any time to exit the setting.

NOTE: The display menu may vary while different input source was selected.

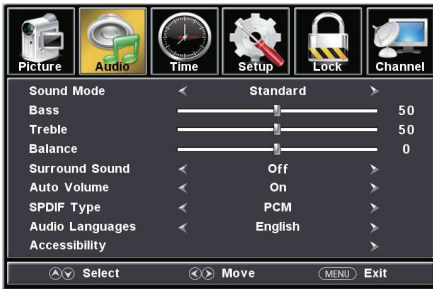

Audio Menu

Sound Mode	Select the sound mode.	Press ◀ / ▶ buttons to select Music > Movie > User > Standard . <u>Music</u> : To preserve the original sound. <u>Movie</u> : To enhance treble and bass for a rich sound. <u>User</u> : To customize audio settings. <u>Standard</u> : To produce a balanced sound in all environments.
Bass	Control the bass level.	Press ◀ or ▶ button to increase or decrease low frequency intensity.
Treble	Control the treble level.	Press ◀ or ▶ button to increase or decrease high frequency intensity.
Balance	Control the balance level.	Press ◀ or ▶ button to adjust sound towards the left or right speaker.
Surround Sound	Control the surround sound	Press ◀ or ▶ buttons to select Off / On .
Auto Volume	Adjust the volume automatically.	Press ◀ or ▶ buttons to select Off / On .
Audio Languages (only Digital TV mode)	Select the language supported by the chosen digital channel.	Press ◀ or ▶ button to select different Audio Languages.
MTS (only Analog TV mode)	Configures the multi-track sound.	Press ◀ or ▶ button to select Stereo / SAP / Mono .
SPDIF Type	Send digital audio to external audio system.	Press ◀ or ▶ button to select Raw / Off / PCM .
Accessibility	Configure the VoiceGuide / VideoDescription .	Press ▶ button to enter sub-menu VoiceGuide / VideoDescription .

TV Settings

Time Setting

1. Press **MENU** button to remote control to enter the main menu.
2. Use ◀ or ▶ to highlight **Time** mode.
3. Use ▲ or ▼ to highlight the item you would like to reset, then press ◀ or ▶ to select the settings.
4. Press **MENU** to return to the previous menu or press **EXIT** at any time to exit the setting.



Time Menu

Sleep Timer	Set the countdown time before TV automatically shutdown.	Press ◀ or ▶ button to select 5min > 10min > 15min > 30min > 45min > 60min > 90min > 120min > 180min > 240min > Off .
Time Zone	Set the time zone.	Press ◀ or ▶ buttons to select Eastern > Central > Mountain > Pacific > Alaska > Hawaii > Atlantic .
Daylight Savings Time	Turn on/off daylight saving time.	Press ◀ or ▶ button to set as On or Off .
Time Format	Select the time display format.	Press ◀ or ▶ button to set as 12-hour or 24-hour .
Auto Clock	Set automatic time.	Press ◀ or ▶ button to set as On or Off .
Clock	Display the current date and time.	The date and time are automatically set the first time when the tuner receives a broadcast channel.

TV Settings

Lock Setting

1. Press **MENU** button to remote control to enter the main menu.
2. Use **◀** or **▶** to highlight **Lock** mode.
3. Use **▲** or **▼** to highlight “**Enter Password**” and input “**0000**” to enter the setup window.
4. Use **▲** or **▼** to highlight the item you would like to reset, then press **◀** or **▶** to select the settings.
5. Press **MENU** to return to the previous menu or press **EXIT** at any time to exit the setting.



Lock Menu

Enter Password	Input the password to access the Lock menu.	Use the Number Buttons (0-9) to enter the password. * Default password is 0000. * If you forgot the password, use 8888 to enter any locked menu.	
Set Password	Change the User Password. Press ▶ to enter your new password, then input it again to confirm the password.	Set Password	Use Number buttons (0-9) to enter a new password.
		Confirm Password	Repeat the password to confirm.
System Lock	Change the parental controls.	Press ◀ or ▶ to set as On or Off .	
US	Set up parental locks based on US rating system . * Only available when System Lock is set as On mode.	TV	Press ▶ to enter the TV Ratings menu and use ▲ / ▼ / ◀ / ▶ to select your TV rating preference. (Refer to the following tables of Age and Genre)
		MPAA	Press ◀ / ▶ buttons to select your movie rating preference based on US Rating System .
Canada	Set up parental locks based on Canadian rating system . * Only available when System Lock was set as On mode.	Canada English	Press ◀ / ▶ buttons to select your ratings preference based on Canadian Rating System (English) .
		Canada French	Press ◀ / ▶ buttons to select your ratings preference based on Canadian Rating System (French) .

TV Settings

Lock Menu

RRT Setting	Not user adjustable settings.	
Reset RRT	Restore to default RRT settings.	Press ► to select Yes or No .
Clear Lock	Restore to default V-chip settings and clear the lock setting.	Press ► to select Yes or No .

TV RATING

	All	FV	V	S	L	D
TV-Y						
TV-Y7						
TV-G						
TV-PG						
TV-14						
TV-MA						

Lock Press OK to Lock or Unlock

Move Select Return

US Rating System

Off	All Ages
G	General Audience
PG	Parental Guidance
PG-13	Parental Guidance below 13 years
R	Parental Guidance below 17 years
NC-17	Suitable for 17 years old or above
X	Adults Only

Genre

ALL	All
FV	Fantasy Violence
V	Violence
S	Sex
L	Language
D	Dialogue

Canadian Rating System (English)

E	Exempt from the ratings (All ages)
C	Suitable for children age of 0-7 years
C8+	Suitable for children age over 8 years
G	General Audience
PG	Parental Guidance
14+	Suitable for viewers age over 14 years
18+	Suitable for adults over 18 years

Age

TV-Y	All Children
TV-Y7	Suitable for 7 years old or above
TV-G	General Audience
TV-PG	Parental Guidance
TV-14	Suitable for 14 years old or above
TV-MA	Suitable for 17 years old or above

Canadian Rating System (French)

E	Exempt from the ratings (All ages)
G	General Audience
8 ans+	Suitable for children ages over 8 years
13 ans+	Suitable for children ages over 13 years
16 ans+	Suitable for viewers ages over 16 years
18 ans+	Suitable for adults over 18 years

TV Settings

Channel Setting

1. Press **MENU** button on remote control to enter the main menu.
2. Use **◀** or **▶** to highlight **Channel** mode.
3. Use **▲** or **▼** to highlight the item you would like to reset, then press **◀** or **▶** to select the settings.
4. Press **OK** to confirm your selections or settings and enter the sub menus.
5. Press **MENU** to return to the previous menu or press **EXIT** at any time to exit the setting.



Channel Menu

Air/Cable	Set the reception type.	Press ◀ or ▶ button to select Air or Cable based on your antenna connection. • Select Air when TV is connected to an indoor / outdoor antenna. • Select Cable if you subscribe to a pay television service WITHOUT a set top box.
Auto Scan	Automatically scan for available channels. Press ▶ or OK to enter sub menu.	Cable System Press ◀ or ▶ button to select STD / IRC / HRC / Auto . (Only available when you select Cable as the reception type.) Press ▲ or ▼ button to highlight Start to Scan , then press ▶ / OK button to start scanning available channels.
		Air Mode Press ▼ to highlight Start to Scan directly, then press ▶ / OK button to start Auto Scan .
Favorite	Add or delete a channel in the favorite list.	Press ▲ or ▼ button to select a channel, then press ENTER button to add or delete the channel in the favorite list. A checkmark indicates a channel has been added. You may also display your list of Favorite channels by pressing the FAV button on the remote control.
Channel List	Display your program list.	Press ▶ button to enter.
Show / Hide	Show or hide the channels in your program list.	Press ▶ to enter sub-menu to show or hide channels already in memory. Use ◀ / ▶ / ▼ / ▲ buttons to access the list of available channels. Press ENTER to change the channels status. A checkmark will appear to indicate that a channel has been added.
Channel No.	Select a channel number to be labeled.	Press ◀ or ▶ button to select a channel to be labeled.
Channel Label	Allow custom labeling to name or rename a channel.	Press ▲ / ▼ buttons to highlight Channel Label to name or rename a channel. Press ▶ to enter the sub-menu to relabel a channel. Use ▼ / ▲ buttons to spell out each letter, number or character. Use ◀ / ▶ buttons to skip to the next space.
DVT Signal.	Display the current signal status.	

Change Settings

USB Mode

1. After connecting a flash drive, press **Input** button on the remote control to display the Input Menu.
2. Press **▲** / **▼** buttons to select **Media** in the Source menu, and then press **ENTER** button to confirm.



Music

- Press **◀** / **▶** buttons to select **Music**.
Press **▲** / **▼** buttons to select the song you want to hear.
Press **ENTER** to start playing the song.
Press **◀◀** or **▶▶** to skip to the next/previous song.
Press **▶||** to stop playback.

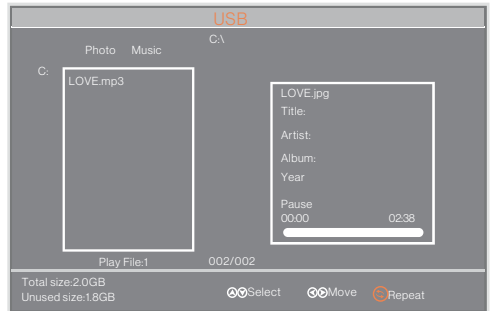

Photo

- Press **◀** / **▶** buttons to select **Photo**.
Press **▲** / **▼** buttons to select the photo you want to view.
Press **ENTER** to view the photo.
Press **◀◀** or **▶▶** to view the next photo.
Press **▶||** to return main menu.

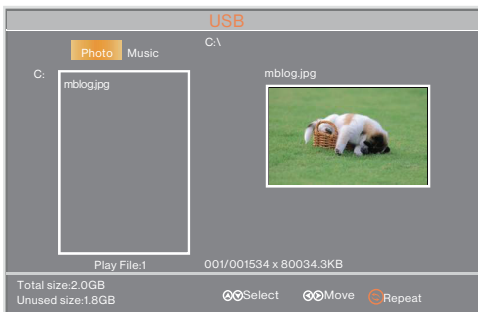

Troubleshooting

Problem	Solution/Issue
TV does not operate	<ul style="list-style-type: none"> • Make sure the power cord is plugged in. • Try another AC outlet. • Power is off, check fuse or circuit breaker. • Unplug unit for an hour, then plug it back in.
Normal picture, but no sound	<ul style="list-style-type: none"> • Check the volume settings. • Sound muted? Press MUTE button. • Try another channel. • Check audio cable connections.
The remote control does not work	<ul style="list-style-type: none"> • Make sure the remote control is in range with no obstructions. • Check the batteries. • Correct operating mode set: TV, VCR etc.
Poor sound or no sound	<ul style="list-style-type: none"> • Station or Cable TV experiencing problems, tune to another station. • Check sound adjustments (Volume or Mute). • Check for sources of possible interference.
Poor picture or no picture	<ul style="list-style-type: none"> • Station or Cable TV experiencing problems, tune to another station. • Make sure channels are set into memory. • Check antenna or Cable TV connections, adjust antenna. • Check the possible interference sources. • Check picture control adjustments.
Poor TV reception	<ul style="list-style-type: none"> • Ensure the antenna amplifier is turned on for Antenna TV. • Adjust the antenna position to a stronger signal receiving angle. • Check if the Antenna connection is tight to the TV. • Check if there is power supplied to the Antenna distribution box. • Confirm your incoming cable is connected to the correct cable / antenna wall connection inside the RV. • Ensure the internal RV coax jump cable is connected to the correct port.
Poor Cable / Satellite TV Reception	<ul style="list-style-type: none"> • Ensure antenna amp is turned off for cable signal. • Check if incoming Cable is connected correctly to RV. • Ensure cable splitter box has power. • Check if the incoming cable is connected to the correct cable / Satellite wall connection inside your RV. • Ensure the internal RV coax jump cable is connected to the correct port. • Ensure Dish has no obstruction.
TV shuts off	<ul style="list-style-type: none"> • Sleep Timer is set. • Power interrupted.
Black and white image from the connected AV device	<ul style="list-style-type: none"> • Check video connections on both the TV and connected AV device. Ensure the colors match between the connectors and sockets: green (Y), blue (Pb/Cb) and red (Pr/Cr) for component connection, and yellow (VIDEO) for composite connection. • Ensure all video cables are connected firmly.

Specifications

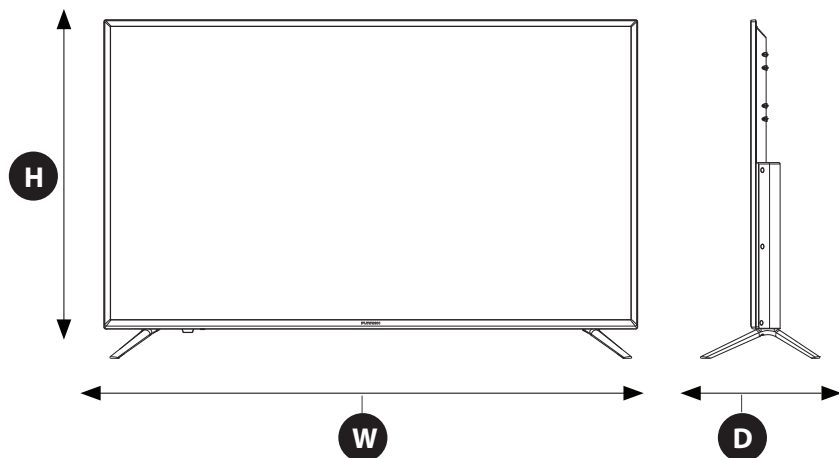

MODEL, DIMENSION & RESOLUTION

Model	Dimension without Stand (W*H*D)	Dimension with Stand (W*H*D)	Max Resolution
FDHS39Y1A	35 $\frac{1}{16}$ " x 20 $\frac{1}{4}$ " x 2 $\frac{7}{8}$ " (890 x 515 x 73mm)	35 $\frac{1}{16}$ " x 21 $\frac{7}{8}$ " x 7 $\frac{9}{16}$ " (890 x 556 x 192mm)	1366 x 768 @ 60Hz HD

INPUT & OUTPUT CONNECTIONS

Model	EARPHONE	OPTICAL OUT	VIDEO IN	L-AUDIO IN-R	Y,P,B, VIDEO IN	HDMI IN	RF IN	USB
FDHS39Y1A	1	1	1	1 x White (L) 1 x Red (R)	1 x Green 1 x Blue 1 x Red	3	1	1

Specifications

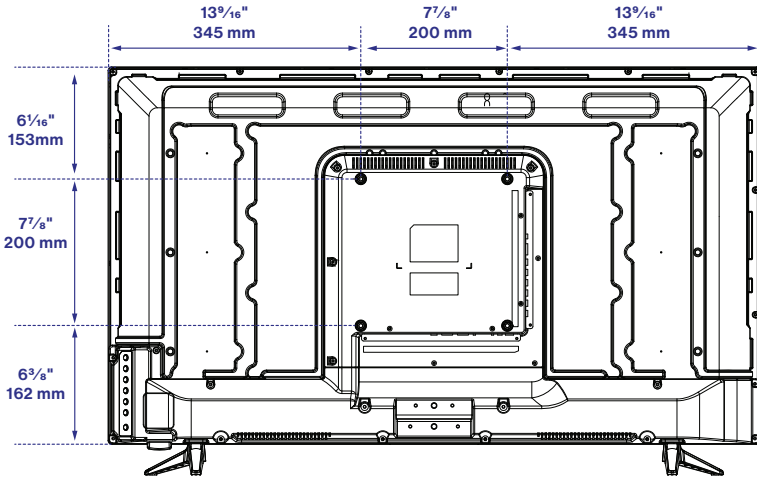

VESA MOUNTING PATTERN

Model	Width mm	Height mm	Screw Size	Quantity
FDHS39Y1A	200	200	M6*10 mm	4

FURRION

Furrion Innovation Center & Institute of Technology

- 52567 Independence Ct., Elkhart, IN 46514, USA • Toll free: 1-800-789-3341
- Email: support@furrion.com

©2007-2020 Furrion Ltd. Furrion® and the Furrion logo are trademarks licensed for use by Furrion Ltd. and registered in the U.S. and other countries.

FURRION.COM